

Turing Machines

Wolfgang Schreiner
Wolfgang.Schreiner@risc.jku.at

Research Institute for Symbolic Computation (RISC)
Johannes Kepler University, Linz, Austria
<http://www.risc.jku.at>

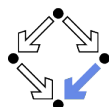

1. Turing Machines

2. Recognizing Languages

3. Generating Languages

4. Computing Functions

5. The Church-Turing Thesis

Turing Machine Model

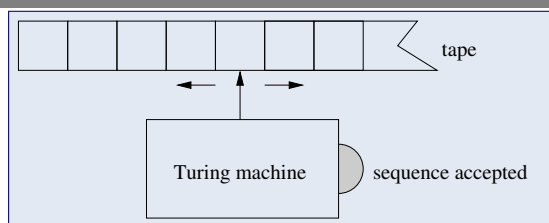
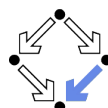

- The machine is always in one of a **finite set of states**.
 - The machine starts its execution in a fixed start state.
- An **infinite tape** holds at its beginning the input word.
 - Tape is read and written and arbitrarily moved by the machine.
- The machine proceeds in a sequence of state **transitions**.
 - Machine reads symbol, overwrites it, and moves tape head left or right.
 - The symbol read and the current state determine the symbol written, the move direction, and the next state.
- If the machine cannot make another transition, it **terminates**.
 - The machine signals whether it is in an accepting state.

If the machine terminates in an accepting state, the word is **accepted**.

Turing Machines

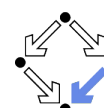

Turing Machine $M = (Q, \Gamma, \sqcup, \Sigma, \delta, q_0, F)$:

- The **state set** Q , a finite set of **states**.
- A **tape alphabet** Γ , a finite set of **tape symbols**.
- The **blank symbol** $\sqcup \in \Gamma$.
- An **input alphabet** $\Sigma \subseteq \Gamma \setminus \{\sqcup\}$.
- The (partial) **transition function** $\delta : Q \times \Gamma \rightarrow_p Q \times \Gamma \times \{ 'L', 'R' \}$,
 - $\delta(q, x) = (q', x', 'L'/'R')$... M reads in state q symbol x , goes to state q' , writes symbol x' , and moves the tape head left/right.
- The **start state** $q_0 \in Q$
- A set of **accepting states (final states)** $F \subseteq Q$.

The crucial difference to an automaton is the infinite tape that can be arbitrarily moved and written.

Example

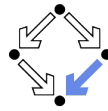

$M = (Q, \Gamma, \sqcup, \Sigma, \delta, q_0, F)$
 $Q = \{q_0, q_1, q_2, q_3, q_4\}$
 $\Gamma = \{\sqcup, 0, 1, X, Y\}$
 $\Sigma = \{0, 1\}$
 $F = \{q_4\}$

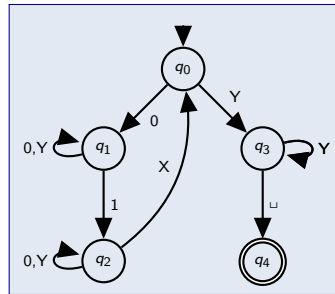

δ	\sqcup	0	1	X	Y
q_0	—	(q_1, X, R)	—	—	(q_3, Y, R)
q_1	—	$(q_1, 0, R)$	(q_2, Y, L)	—	(q_1, Y, R)
q_2	—	$(q_2, 0, L)$	—	(q_0, X, R)	(q_2, Y, L)
q_3	(q_4, \sqcup, R)	—	—	—	(q_3, Y, R)
q_4	—	—	—	—	—

Machine accepts every word of form $0^n 1^n$ (replacing it by $X^n Y^n$).

Turing Machine Simulator

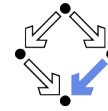

<http://math.hws.edu/eck/js/turing-machine/TM.html>

Old State	Old Symbol	New Symbol	New State	Move
0	#	#	h	R
0	a	@	1	R
0	b	@	5	R
0	c	@	9	R
1	#	#	2	R
1	other	same	1	R
2	#	a	3	L
2	other	same	2	R

Generalized Turing Machines

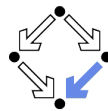

- Infinite tape in **both directions**.
 - Can be simulated by a machine whose tape is infinite in one direction.
- **Multiple** tapes.
 - Can be simulated by a machine with a single tape.
- **Nondeterministic** transitions.
 - We can simulate a nondeterministic M by a deterministic M' .
 - Let r be the maximum number of "choices" that M can make.
 - M' operates with 3 tapes.
 - Tape 1 holds the input (tape is only read).
 - M' writes to tape 2 all finite sequences of numbers $1, \dots, r$.
 - First all sequences of length 1, then all of length 2, etc.
 - After writing sequence $s_1 s_2 \dots s_n$ to tape 2, M' simulates M on tape 3.
 - M' copies the input to tape 3 and performs at most n transitions.
 - In transition i , M attempts to perform choice s_i .
 - If choice i is not possible or M terminates after n transitions in a non-accepting state, M' continues with next sequence.
 - If M terminates in accepting state, M' accepts the input.

Every generalized Turing machine can be simulated by the core form.

1. Turing Machines

2. Recognizing Languages

3. Generating Languages

4. Computing Functions

5. The Church-Turing Thesis

Turing Machine Configurations

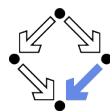

- **Configuration** $a_1 \dots a_k q a_{k+1} \dots a_m$:
 - q : the current state of M .
 - a_{k+1} : the symbol currently under the tape head.
 - $a_1 \dots a_k$: the portion of the tape left to the tape head.
 - $a_{k+2} \dots a_m$: the portion right to the head (followed by $\sqcup \dots$).
- **Move relation**: $a_1 \dots a_k q a_{k+1} \dots a_m \vdash b_1 \dots b_l p b_{l+1} \dots b_m$
 If M is a situation described by the left configuration, it can make a transition to the situation described by the right configuration.
 - $a_i = b_i$ for all $i \neq k+1$ and one of the following:
 - $l = k+1$ and $\delta(q, a_{k+1}) = (p, b_l, R)$,
 - $l = k-1$ and $\delta(q, a_{k+1}) = (p, b_{l+2}, L)$.
- **Extended move relation**: $c_1 \vdash^* c_2$
 M can make in an arbitrary number of moves a transition from the situation described by configuration c_1 to the one described by c_2 .

$$c_1 \vdash^0 c_2 \Leftrightarrow c_1 = c_2$$

$$c_1 \vdash^{i+1} c_2 \Leftrightarrow \exists c : c_1 \vdash^i c \wedge c \vdash c_2$$

$$c_1 \vdash^* c_2 \Leftrightarrow \exists i \in \mathbb{N} : c_1 \vdash^i c_2$$

The Language of a Turing Machine

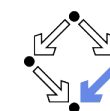

- The **language** $L(M)$ of Turing machine $M = (Q, \Gamma, \sqcup, \Sigma, \delta, q_0, F)$:
 The set of all inputs that drive M from its initial configuration to a configuration with an accepting state such that from this configuration no further move is possible:

$$L(M) := \left\{ w \in \Sigma^* \mid \begin{array}{l} \exists a, b \in \Gamma^*, q \in Q : q_0 w \vdash^* a q b \wedge q \in F \\ \wedge \neg \exists a', b' \in \Gamma^*, q' \in Q : a q b \vdash a' q' b' \end{array} \right\}$$

- L is a **recursively enumerable language**:
 - There exists a Turing machine M such that $L = L(M)$.
- L is a **recursive language**:
 - There exists a Turing machine M such that $L = L(M)$ and M terminates for every possible input.

Every recursive language is recursively enumerable; as we will see, the converse does not hold.

Recursiv. Enumerable/Recursive Languages

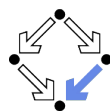

Theorem: L is recursive, if and only if both L and its complement \bar{L} are recursively enumerable.

Proof \Rightarrow : Let L be a recursive. Since by definition L is recursively enumerable, it remains to be shown that also \bar{L} is recursively enumerable.

Since L is recursive, there exists a Turing machine M such that M halts for every input w : if $w \in L$, then M accepts w ; if $w \notin L$, then M does not accept w . With the help of M , we can construct the following M' with $L(M') = \bar{L}$:

```
function M'(w):
  case M(w) of
    yes: return no
    no:  return yes
  end case
end function
```

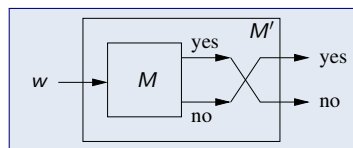

Recursiv. Enumerable/Recursive Languages

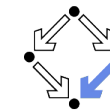

Proof \Leftarrow : Let L be such that both L and \bar{L} are recursively enumerable. We show that L is recursive. Since L is r.e., there exists M such that $L = L(M)$ and M halts for $w \in L$ with $M(w) = \text{yes}$. Since \bar{L} is r.e., there exists \bar{M} with $\bar{L} = L(\bar{M})$ and \bar{M} halts for $w \in \bar{L}$ with $\bar{M}(w) = \text{yes}$. We can thus construct M'' with $L(M'') = L$ that always halts:

```
function M''(w):
  parallel
  begin
    if M(w) = yes then
      return yes
    end if
  loop forever
  end
  begin
    if M-bar(w) = yes then
      return no
    end if
  loop forever
  end
end parallel
end function
```

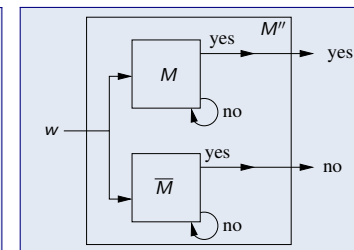

Closure of Recursive Languages

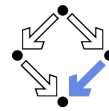

Let L, L_1, L_2 be recursive languages. Then also

- the complement \bar{L} ,
- the union $L_1 \cup L_2$,
- the intersection $L_1 \cap L_2$

are recursive languages.

Proof by construction of the corresponding Turing machines.

1. Turing Machines

2. Recognizing Languages

3. Generating Languages

4. Computing Functions

5. The Church-Turing Thesis

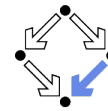

Enumerators

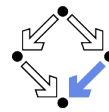

Turing machine $M = (Q, \Gamma, \sqcup, \emptyset, \delta, q_0, F)$ with special symbol $\# \in \Gamma$.

- M is an **enumerator**, if M has an additional **output tape** on which
 - M moves its tape head only to the right, and
 - M writes only symbols different from \sqcup .
- The **generated language** $Gen(M)$ of enumerator M is the set of all words that M eventually writes on its output tape.
 - The end of each word is marked by a trailing $\#$.

M may run forever and thus $Gen(M)$ may be infinite.

Recognizing versus Generating Languages

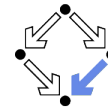

Theorem: L is recursively enumerable, if and only if there exists some enumerator M such that $L = Gen(M)$.

Proof \Rightarrow : Let L be recursively enumerable, i.e., $L = L(M')$ for some M' . We construct enumerator M such that $L = Gen(M)$.

```
procedure M:
  loop
    produce next (m, n) on working tape
    if M'(w_m) = yes in at most n steps then
      write w_m to output tape
    end if
  end loop
end procedure
```

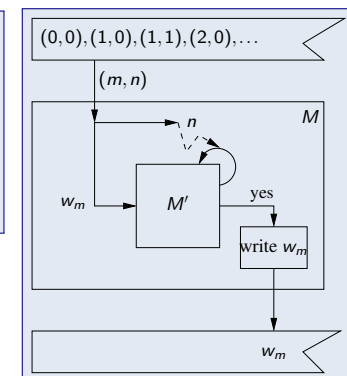

Recognizing versus Generating Languages

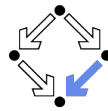

Proof \Leftarrow : Let L be such that $L = \text{Gen}(M)$ for some enumerator M . We show that there exists some Turing machine M' such that $L = L(M')$.

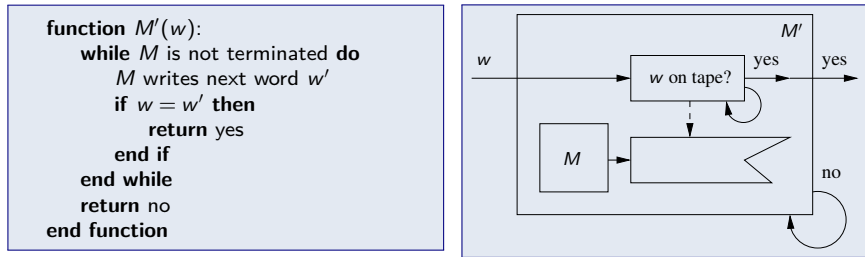

Recognizing is possible, if and only if generating is possible.

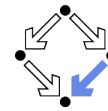

1. Turing Machines
2. Recognizing Languages
3. Generating Languages
4. Computing Functions
5. The Church-Turing Thesis

Functions

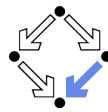

Take binary relation $f \subseteq A \times B$.

- $f : A \rightarrow B$: f is a **total function** from A to B .
 - For every $a \in A$, there is **exactly one** $b \in B$ such that $(a, b) \in f$.
- $f : A \rightarrow_p B$: f is a **partial function** from A to B .
 - For every $a \in A$, there is **at most one** $b \in B$ such that $(a, b) \in f$.
- Auxiliary notions:

$$\text{domain}(f) := \{a \mid \exists b : (a, b) \in f\}$$

$$\text{range}(f) := \{b \mid \exists a : (a, b) \in f\}$$

$$f(a) := \text{such } b : (a, b) \in f$$

Every total function $f : A \rightarrow B$ is a partial function $f : A \rightarrow_p B$; every partial function $f : A \rightarrow_p B$ is a total function $f : \text{domain}(f) \rightarrow B$.

Functions

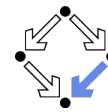

- Let $f : \Sigma^* \rightarrow_p \Gamma^*$ where $\sqcup \notin \Sigma \cup \Gamma$.
 - f is a function over words in some alphabets.
- f is **Turing computable**, if there exists a Turing machine M such that
 - for input w (i.e. initial tape content $w \sqcup \dots$), M terminates in an accepting state, if and only if $w \in \text{domain}(f)$;
 - for input w , M terminates in an accepting state with output w' (i.e. final tape content $w' \sqcup \dots$), if and only if $w' = f(w)$.
- **Not every function $f : \Sigma^* \rightarrow_p \Gamma^*$ is Turing computable:**
 - The set of all Turing machines is countably infinite: all machines can be ordered in a single list (in the alphabetic order of their definitions).
 - The set of all functions $\Sigma^* \rightarrow_p \Gamma^*$ is more than countably infinite (Cantor's diagonalization argument).
 - Consequently, there are more functions than Turing machines.

M computes f , if M terminates for arguments in the domain of f with output $f(a)$ and does not terminate for arguments outside the domain.

Example

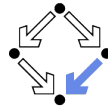

We show that natural number subtraction is Turing computable.

- Subtraction \ominus on \mathbb{N} :

$$m \ominus n := \begin{cases} m - n & \text{if } m \geq n \\ 0 & \text{else} \end{cases}$$

- Unary representation of $n \in \mathbb{N}$:

$$\underbrace{000\dots0}_n \in L(0^*)$$

- Input $00 \sqcup 0$ shall lead to output 0.
 - $2 \ominus 1 = 1$.

Idea: replace every pair of 0 in m and n by \sqcup .

Example (Contd)

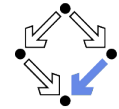

$M = (Q, \Gamma, \Sigma, \delta, q_0, F)$
 $Q = \{q_0, \dots, q_6\}$
 $\Sigma = \{0\}, \Gamma = \{0, 1, \sqcup\}, F = \{q_6\}$

δ	0	1	\sqcup
q_0	(q_1, \sqcup, R)	(q_5, \sqcup, R)	(q_5, \sqcup, R)
q_1	$(q_1, 0, R)$	$(q_2, 1, R)$	$(q_2, 1, R)$
q_2	$(q_3, 1, L)$	$(q_2, 1, R)$	(q_4, \sqcup, L)
q_3	$(q_3, 0, L)$	$(q_3, 1, L)$	(q_0, \sqcup, R)
q_4	$(q_4, 0, L)$	(q_4, \sqcup, L)	$(q_6, 0, R)$
q_5	(q_5, \sqcup, R)	(q_5, \sqcup, R)	(q_6, \sqcup, R)
q_6	—	—	—

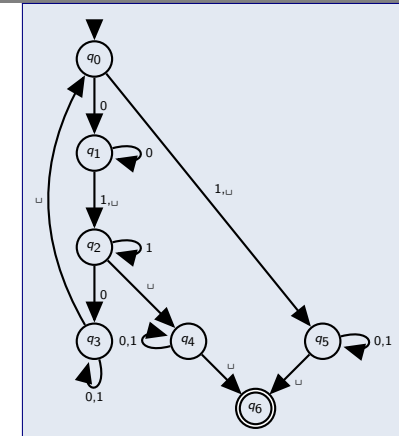

- In q_0 , the leading 0 is replaced by \sqcup .
- In q_1 , M searches for the next \sqcup and replaces it by a 1.
- In q_2 , M searches for the next 0 and replaces it by 1, then moves left.
- In q_3 , M searches for previous \sqcup , moves right and starts from begin.
- In q_4 , M has found a \sqcup instead of 0 and replaces all previous 1 by \sqcup .
- In q_5 , n is (has become) 0; the rest of the tape is erased.
- In q_6 , the computation successfully terminates.

Example (Contd)

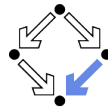

- $2 \ominus 1 = 1$:

$q_0 00 \sqcup 0 \vdash \sqcup q_1 0 \sqcup 0 \vdash \sqcup 0 q_1 \sqcup 0 \vdash \sqcup 0 1 q_2 0$
 $\vdash \sqcup 0 q_3 1 1 \vdash \sqcup q_3 0 1 1 \vdash q_3 \sqcup 0 1 1 \vdash \sqcup q_0 0 1 1$
 $\vdash \sqcup \sqcup q_1 1 1 \vdash \sqcup \sqcup 1 q_2 1 \vdash \sqcup \sqcup 1 1 q_2 \vdash \sqcup \sqcup 1 q_4 1$
 $\vdash \sqcup \sqcup q_4 1 \vdash \sqcup q_4 \vdash \sqcup 0 q_6$

- $1 \ominus 2 = 0$:

$q_0 0 \sqcup 0 0 \vdash \sqcup q_1 \sqcup 0 0 \vdash \sqcup 1 q_2 0 0 \vdash \sqcup q_3 1 1 0$
 $\vdash q_3 \sqcup 1 1 0 \vdash \sqcup q_0 1 1 0 \vdash \sqcup \sqcup q_5 1 0 \vdash \sqcup \sqcup \sqcup q_5 0$
 $\vdash \sqcup \sqcup \sqcup q_5 \vdash \sqcup \sqcup \sqcup \sqcup q_6$

For $m > n$, leading blanks still have to be removed.

Turing Computability

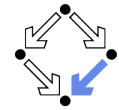

Theorem: $f : \Sigma^* \rightarrow_p \Gamma^*$ is Turing computable, if and only if

$$L_f := \{(a, b) \in \Sigma^* \times \Gamma^* \mid a \in \text{domain}(f) \wedge b = f(a)\}$$

is recursively enumerable.

Proof \Rightarrow : Since $f : \Sigma^* \rightarrow_p \Gamma^*$ is Turing computable, there exists a Turing machine M which computes f . To show that L_f is r.e., we construct M' with $L(M') = L_f$:

```
function M'(a, b):
  b' ← M(a)
  if b' = b then
    return yes
  else
    return no
  end if
end function
```

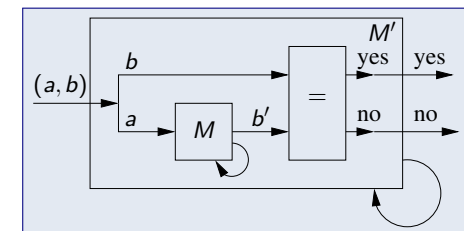

Turing Computability

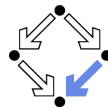

Proof \Leftarrow : Since L_f is recursively enumerable, there exists an enumerator M with $Gen(M) = L_f$. We construct the following Turing machine M' which computes f :

```

function  $M'(a)$ :
  while  $M$  is not terminated do
     $M$  writes  $(a', b')$  to tape
    if  $a = a'$  then
      return  $b'$ 
    end if
  end while
loop forever
end function
        
```

Computing is possible, if and only if recognizing is possible.

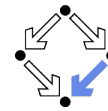

1. Turing Machines
2. Recognizing Languages
3. Generating Languages
4. Computing Functions
5. The Church-Turing Thesis

Algorithms

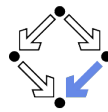

Computer science is based on algorithms.

Compute as follows the greatest common divisor of two natural numbers m, n that are not both 0:

1. If $m = 0$, the result is n .
2. If $n = 0$, the result is m .
3. If $m > n$, subtract n from m and continue with step 1.
4. Otherwise subtract m from n and continue with step 1.

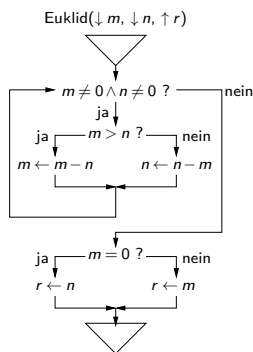

```

Euklid( $\downarrow m, \downarrow n, \uparrow r$ ):
  while  $m \neq 0 \wedge n \neq 0$  do
    if  $m > n$ 
      then  $m \leftarrow m - n$ 
      else  $n \leftarrow n - m$ 
    if  $m = 0$ 
      then  $r \leftarrow n$ 
      else  $r \leftarrow m$ 
  end Euklid.
        
```

What is an “algorithm” and what is computable by an algorithm?

The Church-Turing Thesis

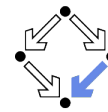

Church-Turing Thesis: Every problem that is solvable by an algorithm (in an intuitive sense) is solvable by a Turing machine. Thus the set of intuitively computable functions is identical with the set of Turing computable functions.

- Replaces fuzzy notion “algorithm” by precise notion “Turing machine”.
- Unprovable thesis, exactly because the notion “algorithm” is fuzzy.
- Substantially validated, because many different computational models have no more computational power than Turing machines.
 - Random access machines, loop programs, recursive functions, goto programs, λ -calculus, rewriting systems, grammars, ...

Turing machines represent the most powerful computational model known, but there are many other equally powerful (“Turing complete”) models.